

144MHz FM TRANSCEIVER

TH-225A

INSTRUCTION MANUAL

KENWOOD CORPORATION

©PRINTED IN JAPAN B50-8334-00(K, P)(T)
90/12 11 10 9 8 7 6 5 4 3 2 1 89/12 11 10

KENWOOD

Thank you for purchasing this new transceiver.

IMPORTANT

Please read this instruction manual carefully before placing your transceiver in service.

SAVE THIS INSTRUCTION MANUAL.

Under normal circumstances, the transceiver will operate in accordance with these operating instructions. The transceiver was preset at the factory and should only be readjusted by a qualified technician with proper test equipment. Attempting service or alignment without factory authorization can void the transceiver's warranty.

CAUTION:

Long transmission or extended operation in the 6 watt mode might cause the rear of this transceiver to get warm. Do not place the transceiver where the heat sink (rear panel) might come in contact with plastic or vinyl surfaces.

Use of an external antenna for fixed station is recommended.

FCC WARNING:

This equipment may generate or use radio frequency energy. Changes or modifications to this equipment may cause harmful interference unless the modifications are expressly approved in the instruction manual. The user could lose the authority to operate this equipment if an unauthorized change or modification is made.

CONTENTS

ACCESSORIES	3
SPECIFICATIONS	4
BATTERY PACK	5
Ni-Cd battery	
Recharging the battery pack	
Manganese/Alkaline batteries	
Operating time	
CONTROLS AND FUNCTIONS.....	6
OPERATION.....	10
Receive	
Transmit	
Frequency selection	11
Repeater operation	12
Transmitter offsets	
Reverse function	
Tone operation	
Auto patch operations	13
Scan	14
Beep tone	
Memory	15
Memory channels	
Memory entry	
Memory recall	
Odd Split memory channel	
Memory channel lockout	16
Clearing a specific memory channel	
Clearing all memories	
Memory back-up battery	
Priority alert channel check	
Battery saver	17

MAINTENANCE	18
In case of difficulty	
Service	
OPTIONAL ACCESSORIES	19
Programmable tone decoder unit TSU-4	
BLOCK DIAGRAM	another sheet
SCHEMATIC DIAGRAM	another sheet

ACCESSORIES

Unpack your transceiver carefully and confirm that it is supplied with the following accessories.

- 1 Antenna for 144 MHz.....T90-0352-051 ea.
- 2 Rubber cap.....B09-0307-141 ea.
- 3 Belt Hook.....J29-0417-04.....1 ea.
- 4 Machine ScrewN35-3005-412 ea.
- 5 Spring washerN16-0030-412 ea.
- 6 Ni-Cd Battery pack
 (PB-12)W09-0541-051 ea.
- 7 Battery charger (120 V) ..W09-0517-051 ea.
- 8 DC cable (PG-2V).....E30-2078-251 ea.
- 9 Instruction ManualB50-8334-XX1 copy
- 10 Warranty Card.....1 ea.

BATTERY PACK

Installing the battery pack

Match the concave part at the bottom of the radio to the convex part at the top of the battery pack.

Turn the battery pack clockwise until it clicks.

Be sure the pack and transceiver are locked together.

Removing

Pressing the battery release button, turn the battery pack counterclockwise.

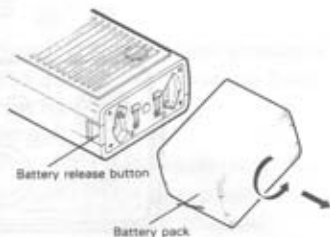

Ni-Cd BATTERY PACK (PB-12)

NOTE:

This battery pack has not been charged at the factory in order to provide you with the greatest number of charge/discharge cycles. You must charge the battery before use. The battery pack will require several charge/discharge cycles before you can expect to see the maximum operating period between charges. If the battery will be stored for greater than 2 months it should be recharged before use.

RECHARGING THE BATTERY PACK

Insert the charge plug from the supplied Battery Charger into the receptacle on the rear of the battery pack. Then plug the Charger into the AC line. The LED on the Charger will illuminate to show that the pack is charging. The LED will remain on as long as the Charger is connected to the AC power source and the battery, indicating that the pack is still being charged. Do not allow the battery to charge for greater than 15 hours. The useful life and battery performance will be reduced if you exceed the recommended charge period.

NOTES:

- Turn off the power switch before charging.
- Recharging should be done within an ambient temperature between 10°C ~ 40°C (50°F ~ 104°F). Recharging performed out of this range may not fully charge the battery.

MANGANESE or ALKALINE BATTERIES

Load 6 × R6 (AA) manganese or alkaline batteries in series in the supplied battery case. (Be sure to observe the polarities.)

(We recommend use of high-performance manganese batteries.) Battery pack (1) can be inserted into the case (2) only in a specific direction. Check the shape (top and bottom) after moving the stopper on the rear side, then insert the battery correctly. Inserting the battery by force without checking the shape may damage the case.

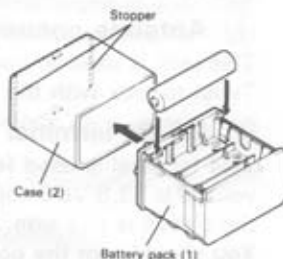

OPERATING TIME

Batt voltage (V)

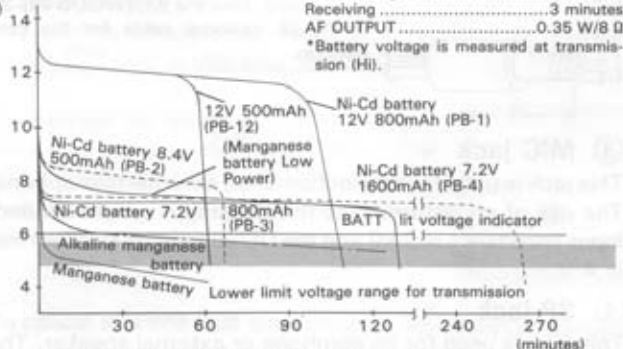

Manganese battery (except Alkaline manganese battery) is suitable only for LOW power transmission. Recharge the Ni-Cd battery pack when the BATT indicator comes on.

We recommend use of the PB-3 or PB-4 Ni-Cd battery pack for long transmission or extended operation.

CONTROLS AND FUNCTIONS

① Antenna connector

This jack is used to connect the supplied antenna. Twist to lock with the BNC connector.

② DC IN terminal

This terminal is used for an external power supply. Input voltage is 13.8 VDC nominal. The center is the (+) side and the sleeve is (-) side.

You should turn the power switch OFF when connecting this terminal. Pay attention to the polarity.

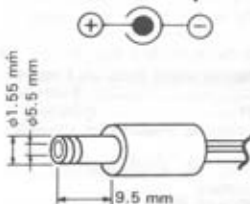

CAUTION:

As a precaution, do not remove the battery pack when an external power supply is used. Use the KENWOOD PG-2V or PG-3E optional cable for the connection.

③ MIC jack

This jack is used for connection of an external microphone. The use of an electret type microphone is recommended. Input impedance is 2 k Ω and the DC voltage on this terminal is 4 V.

④ SP jack

This jack is used for an earphone or external speaker. The recommended impedance is 8 Ω nominal.

⑤ TONE switch

This switch is used to activate the sub-audible tone encoder.

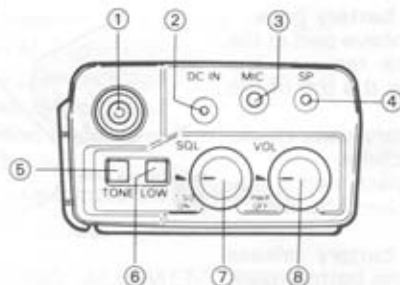

⑥ HI (■)/LOW (▬) switch

This switch is used to select the transmit output power.

⑦ SQL control

The SQL control is used to eliminate noise during no signal periods. Normally, this control is adjusted clockwise until the noise just disappears and the BUSY indicator goes OFF (Threshold level). For scan operation, this control must be set to the threshold point. When an incoming signal is weak or unstable, readjust the squelch for optimum reception. For tone squelch operation with TSU-4, this control must be set to the T.SQ position.

⑧ VOL control

Volume control with power ON/OFF switch.

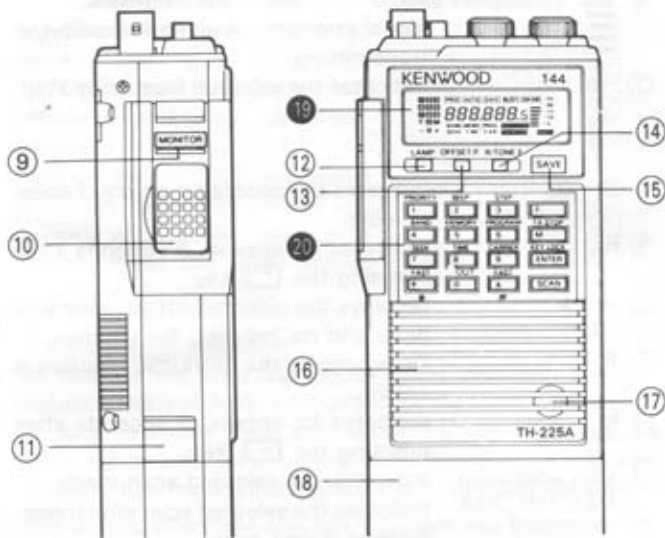

⑨ MONITOR switch

Pressing this key will open squelch.

⑩ PTT (Push To Talk) switch

For transmission, press this switch and speak into the microphone.

⑪ RELEASE button

Used to release the battery.

Depress this button, and turn the battery counterclockwise.

⑫ LAMP key

This key controls the lamp on the LCD display.

NOTE:

When the LAMP is on battery drain will be accelerated. Do not use this feature unnecessarily.

⑬ OFFSET/F key

The OFFSET/F key is used to select the desired transmitter offset for repeater operation. Each time the key is pressed, the mode cycles from + shift, to - shift, to simplex, and back to + shift. When the offset function is ON, the symbol "+" or "-" is displayed.

Pressing the **[F]** and the OFFSET/F key in order is used to change the desired offset frequency.

⑭ R/TONE. F key

This key is used to reverse the transmit/receive frequencies during repeater operation.

TONE. F: TONE FREQUENCY key

Pressing the **[F]** and the R/TONE. F key in order is used to change the frequency of the tone encoder.

⑮ SAVE key

The SAVE key is used to select the power save condition during the receive mode.

Pressing the **[F]** and the SAVE key in order is used to change the battery saver on/off ratio.

⑯ SPEAKER

⑰ MICROPHONE

⑱ BATTERY CASE

19 Display

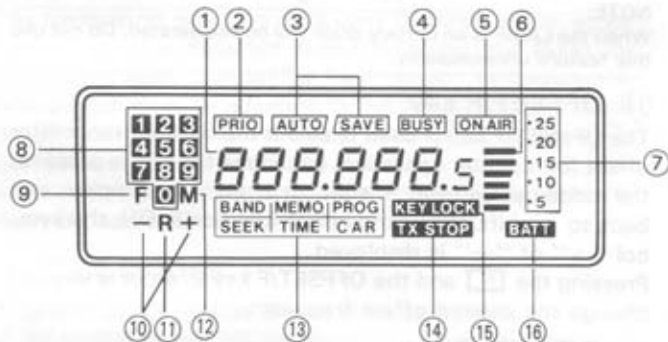

① FREQUENCY display

: Displays the operating frequency.

② PRIO

: ON when the Priority Alert function is active.

③ AUTO / SAVE

: Displays the selected power save condition;

AUTO / **SAVE** for auto save mode, **SAVE** for save mode, and no indicator for OFF.

④ BUSY

: ON whenever the squelch opens during receive.

: ON all the time if the squelch control is rotated counterclockwise, and the T.SQ is off.

⑤ ON AIR

: ON during transmit mode.



: Used to indicate the relative receive signal strength, or as an indication of transmitting.

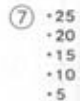

: Indicates the selected frequency step.



: Indicates the selected memory channel number.



: Indicates for approx. 5 seconds after pressing the **F** key.



: Displays the selected offset, minus or plus, and no indicator for simplex.



: On whenever the REVERSE function is active.



: Indicates for approx. 5 seconds after pressing the **M** key.



: Indicates the selected scan mode.

: Indicates the selected scan stop mode. Flashes during scan.



: Indicates that the transmitter has been disabled by the TX.STOP key.



: Indicates that all keyboard functions except LAMP key has been disabled by the KEY LOCK is activated.



: ON when the battery voltage falls below the level for good communications. Recharge/replace the battery pack.

20 DOUBLE ROLE KEYS

PRIORITY	BEEP	STEP	
1	2	3	F
BAND	MEMORY	PROGRAM	TX STOP
4	5	6	M
SEEK	TIME	CARRIER	KEY LOCK
7	8	9	ENTER
FAST	L/OUT	FAST	
▼	0	▲	SCAN
*		#	

These 13 keys except the **F** and **SCAN** keys, have two functions.

The 1st function is printed on the key.

The 2nd function is printed above the key.

All these 2nd functions are active for approx. 5 seconds after pressing the **F** key.

• Numeric keys: 1 ~ 9, 0

These keys are used to select the desired operating frequency and/or memory channel number.

Memory channel 1, 8, and 9 also serve additional functions as described below.

M. channel 1 is used to store the Priority Alert channel information.

M. channel 8 is used to store the lower, and M. channel 9 the upper limit frequency for the programmable band scan.

• UP/DOWN keys: ▲, ▼

These keys are used to increase or decrease the operating frequency, offset frequency, tone frequency, or the power saver circuit rate.

• F: Function exchange key

The **F** key is used to activate the 2nd function.

The F indicator is displayed for approx. 5 seconds after pressing the **F** key.

CAUTION:

You must press the 2nd function while the F indicator is lit, or the radio will perform the function printed on the key, rather than the function printed above it.

• M: Memory key

The **M** key is used to select the desired memory channel.

The operation is similar to that of the **F** key, in that, the M indicator will illuminate for 5 seconds in the LCD display.

CAUTION:

The memory channel must be selected within 5 seconds of pressing the **M** key.

• ENTER key

The **ENTER** key is used to enter a frequency selected by the numeric keys.

• SCAN key

The **SCAN** key is used to start or stop the scan function.

• PRIORITY CHANNEL CHECK key: **F** then 1/PRIO

These keys are used to monitor whether the priority channel (CH 1) is busy or not. When this function is activated, the radio will switch to CH 1 approximately once every 10 seconds.

To cancel this function, press these keys again.

- **BEEP key:** **F** then 2/BEEP

Each time these keys are pressed, the audio annunciator will be turned ON or OFF alternately.

- **(FREQUENCY) STEP key:** **F** then 3/STEP

Each time these keys are pressed, the frequency scanning step size will be increased 5 kHz.

Several different scan function keys and scan stop keys are provided.

- **BAND SCAN key:** **F** then 4/BAND
- **MEMORY SCAN key:** **F** then 5/MEMORY
- **PROGRAMMABLE BAND SCAN key:** **F** then 6/PROGRAM
- **SEEK OPERATED SCAN key:** **F** then 7/SEEK
- **TIME OPERATED SCAN key:** **F** then 8/TIME
- **CARRIER OPERATED SCAN key:** **F** then 9/CARRIER

For additional information on this function refer to page 14.

- **TX. STOP key:** **F** then M/TX. STOP

Pressing these keys will prevent accidental transmission. To cancel this function, press these keys again.

- **KEY LOCK key:** **F** then ENTER/KEY LOCK

Depress these keys and the frequency and other settings will remain unchanged by keyboard operation except the LAMP key.

To cancel this function, press these keys again.

- **FAST ∇ key:** **F** then ∇ /FAST
- **FAST \blacktriangle key:** **F** then \blacktriangle /FAST
- **LOCK OUT key:** **F** then 0/L.OUT

Each time these keys are pressed, the Memory channel lock out function will be turned ON or OFF.

OPERATION

■ RECEIVE

After power and antenna connections have been completed, set the switches as follows:

1. Turn the VOL control clockwise to turn on power. The frequency on the LCD display will show the transceiver is operating.
2. As the VOL control is turned clockwise, either background noise or a QSO will be heard.
3. To eliminate the no-signal noise turn the SQL control clockwise.
4. Enter the desired frequency.

■ TRANSMIT

Precaution: Check the intended transmit frequency before operating to prevent interference with other stations. If you are using T. SQ (Tone Squelch) press the MONITOR key to allow the Squelch to open.

1. Simply depress the PTT switch and the **IN AM** indicator will light.
2. Speak into the microphone. Recommended distance to the microphone is approximately 2 inches (5 cm).



CAUTION:

Long transmission or extended operation in the 6 watt mode might cause the rear of this transceiver to get warm. Do not place the transceiver where the heat sink (rear panel) might come in contact with plastic or vinyl surfaces.

■ FREQUENCY SELECTIONS

Two different methods are provided for frequency selection.

● UP/DOWN key frequency selection

- 1 Pressing either the  or the  key momentarily will cause the displayed frequency to change 1 step up or down, respectively.



The step size is selected by pressing the  and the 3/STEP key from 5 step sizes (5, 10, 15, 20, 25 kHz).



1 step up



1 step down



- 2 Pressing the  or the  key for more than 1 second will cause the frequency to change up or down continuously until the key is released.

- 3 Pressing the  followed by holding the  or the  key will cause the frequency to change quite rapidly.

Rapidly up

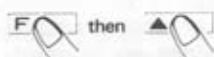

Rapidly down

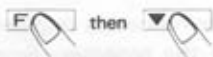

Repeating this operation shifts the displayed frequency as shown below.

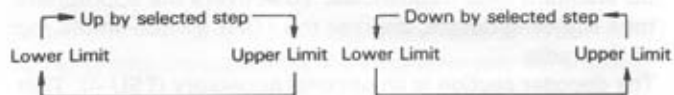

● Direct keyboard frequency entry

Press the  key.

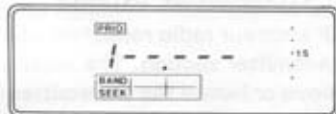

Enter the frequency to the nearest kHz.

For example



The receiver will not change frequency until all digits have been entered.

If you should make an error before entering all digits, press the  key twice, and reenter all digits.

■ REPEATER OPERATION

● Transmitter offsets

All amateur radio repeaters utilize a separate receiver and transmitter section. The receiver frequency may be either above or below the transmitter frequency. The transceiver allows you to store the frequency and offset in memory, or you can select the offset and offset frequency from the keyboard.

Offset direction

To select the desired offset, press the OFFSET/F key. Each time you press the key the radio will advance from one offset to the other, i.e. "+" to "-" to no offset or simplex.

Offset frequency selection

To select the desired offset frequency, press the **F** and the OFFSET/F key. The display shows present transmit offset.

Press either the **▲** key or the **▼** key momentarily, the frequency change 100 kHz step up or down from lower limit 100 kHz to upper limit 9.9 MHz. Press the **ENTER** key to complete the selection.

NOTE:

You can enter any offset you desire, but if you select an offset that would cause the radio to go out of band the radio will ignore the programmed offset, and transmit in the simplex mode. (For MARS and CAP operators who have modified their radios to cover the MARS and CAP frequencies this may not be the case. For these sets the transceiver will accept any offset that does not take it outside its tuning range. See the instructions supplied with the MARS/CAP modification sheet.)

● Reverse function

Some repeaters utilize a "reverse pair", i.e. the transmit/receive frequencies are exactly the reverse of another repeater. For example repeater A uses 146.000 for a transmit frequency (OUTPUT) and 146.600 for receive (INPUT). Repeater B uses 146.000 for its receive and 146.600 for its transmit. It would be inconvenient to have to reprogram the radio each time if you were in range of both repeaters. The R/TONE. F key has been provided to allow you to reverse the transmit and receive frequencies.

To use the REVERSE function, press the R/TONE. F (or press and hold the REVERSE) key. The R indicator will light in the display.

To return to normal offsets press the R/TONE. F (or release the REVERSE) key again. This function is useful to check the input frequency of the repeater so that you can determine if you are within SIMPLEX range.

● Tone operations

Some repeaters require the use of a control signal to activate the repeater. Several versions are currently in use worldwide.

These transceiver provides a subaudible tone encoder with 38 standard tone frequencies. To activate the appropriate tone signaling device, depress the TONE switch on the top of the radio.

The decoder section is an optional accessory (TSU-4). That allows for T.SQ (Tone Squelch) operation. With this option you will only hear those stations that transmit the same subaudible tone directly.

Tone frequency selection

To select the tone frequency, press the **F** and the R/TONE.F key. The display will show a operating tone frequency.

Press either the **▲** key or the **▼** key momentarily, the frequency will change 1 step up or down. Press the **ENTER** key to complete the selection.

Tone Frequency

67.0 Hz	107.2 Hz	167.9 Hz
71.9 Hz	110.9 Hz	173.8 Hz
74.4 Hz	114.8 Hz	179.9 Hz
77.0 Hz	118.8 Hz	186.2 Hz
79.7 Hz	123.0 Hz	192.8 Hz
82.5 Hz	127.3 Hz	203.5 Hz
85.4 Hz	131.8 Hz	210.7 Hz
88.5 Hz	136.5 Hz	218.1 Hz
91.5 Hz	141.3 Hz	225.7 Hz
94.8 Hz	146.2 Hz	233.6 Hz
97.4 Hz	151.4 Hz	241.8 Hz
100.0 Hz	156.7 Hz	250.3 Hz
103.5 Hz	162.2 Hz	

Tone Squelch operation

To actuate the tone squelch function (decode), turn the Squelch control fully counterclockwise past the detent. Squelch will now open only when the radio receives the same subtone frequency. To return to normal noise activated squelch, turn the Squelch control clockwise past the detent. It is a good operating practice to check the frequency before transmitting. A MONITOR switch has been provided for this purpose when using the TONE SQUELCH function. Pressing this switch will open the squelch so you can check for activity.

NOTE:
97.4 Hz is available only for encode.

• Autopatch operations

Some repeaters offer a service known as AUTOPATCH. This allows you to dial a telephone number from your radio and carry out a telephone conversation, much like a car telephone, or cellular telephone.

This function requires the use of a DTMF (Dual Tone Multi Frequency) pad. This is also known as a touch tone pad. It operates just like the touch tone pad on your home telephone. In addition to the normal 12 keys that are found on your telephone the transceiver also provides 4 additional keys A, B, C, and D. These keys are required by some repeater systems for various control functions. You should check with the control operator of your repeater to determine if their use is required. A chart is provided that lists the tones that are generated when you press each key.

To use the touch tone pad you should first key the radio using the PTT switch. Then simply press the numbers corresponding to the telephone number you want to dial. If you do not want to have to hold the PTT switch depressed while dialing you can use the procedure described below.

1. Turn the POWER switch OFF.
2. Press and hold the **F** key.
3. Turn on the POWER switch.
4. Release the **F** key.

Audio tones

(Hz)

Column Row	1209	1336	1477	1633
697	1	2	3	F = A
770	4	5	6	M = B
852	7	8	9	ENTER = C
941	▲ *	0	▼ #	SCAN = D

Then, after you have pressed the first number key the radio will remain keyed for approximately 2 seconds. The radio remains keyed after you press each number for this 2 seconds interval.

■ SCAN

Scan is initiated by pressing the **SCAN** key.

The transceiver will stop on a busy channel. When an incoming signal is detected during scanning, the BUSY indicator will light. In order for this function to operate the SQL control must be adjusted to the threshold point. Scan direction can be selected by either the **▲** or the **▼** key before initiating scan.

The selected scan mode and scan stop mode indicators will flash ON and OFF during scanning.

● SCAN MODES

- 1. BAND SCAN MODE:** Scans the entire band.
- 2. MEMORY SCAN MODE:** Scans the memory channels repeatedly, skipping the vacant channels.
- 3. PROGRAMMABLE BAND SCAN MODE:** Scans between the frequencies stored in memory channels 8 and 9. If the frequency stored in memory channel 8 is the same or greater than in memory 9, or if either or both channels are vacant, scan will proceed over the entire band.

If SCAN is initiated while the displayed frequency is outside the range specified in memory channels 8 and 9, scan will proceed outside of the programmed limits.

In the BAND SCAN and PROGRAMMABLE BAND SCAN MODE, scan proceeds according to the selected step size.

● SCAN STOP AND RESUME MODES

- 1. SEEK OPERATED SCAN:** Scan will stop on a busy channel. Scan will not resume until the **SCAN** key is pressed again.

- 2. TIME OPERATED SCAN:** Scan will stop on a busy channel and resume approx. 5 seconds afterwards. Scan will resume even if the station is still present.
- 3. CARRIER OPERATED SCAN:** Scan will hold as long as the signal is present and resume scan after a 2 second delay if the signal drops out.

Releasing scan: Press one of the following keys during scanning to clear the scan mode.

- a) **SCAN** key b) **PTT** switch

■ BEEP TONE

Audible confirmation of microprocessor function is provided in the form of a series of audio beeps.

To activate beep tones, press the **F** key and 2/BEEP key.

The radio will then supply audio confirmation according to the chart below.

Scale	Frequency (Hz)	Key operation
A	440.00	MR 0
A#	466.16	MR 1
B	493.88	MR 2
C	523.25	MR 3, SAVE ON
C#	554.37	MR 4, OFFSET
D	587.33	MR 5, To select OFFSET Frequency
D#	622.26	MR 6, REV, To select Tone Frequency
E	659.25	MR 7, TXSTOP, SAVE AUTO
F	698.46	MR 8, To change the rate of Power Save time, ENTER
F#	739.98	MR 9, KEYLOCK
G	783.98	DOWN, SAVE OFF
G#	830.61	UP
A	880.00	F
A#	932.33	M
B	987.77	Stopping scanning
F	1396.91	Key operation without effect

■ MEMORY

● MEMORY CHANNELS

The 10 memory channels (1 through 9, and 0) are available for data entry. Channel 1, 8 and 9 have the following functions in addition to its ordinary function.

Channel 1 is the Priority Alert Channel.

Channel 8 is the lower, and channel 9 is the upper limit frequency for the programmable band scan operation.

The 10 memory channels are the Odd Split channel.

Each memory channel can store RX Frequency, F. STEP status, OFFSET, REVERSE switch status and TONE Frequency.

● MEMORY ENTRY

- Press the **[M]** key. The display will indicate M and any memory channels that contain data. (Ex. 1, 4, 7, 8, 9)
2. Press the desired memory channel number (Ex. 5) within 5 seconds of pressing the **[M]** key. This will actually store the information into memory.



● MEMORY RECALL

- Simply press the desired memory channel key and the radio will switch to this frequency.
- To return to the original operating frequency, press the same memory channel key again.

● ODD SPLIT MEMORY CHANNEL

Memory channels store both a transmit, a receive and TONE frequency. These channels will allow operation on "Odd Split" repeater channels.

(For example CH 0)

1. Select the desired receiver frequency, tone status, tone frequency, etc.
2. Press the **[M]** and then the **[0]** key to store this part of the data into memory.
3. Select the desired transmitter frequency.
4. Press the **[M]** key.
5. Within 5 seconds of pressing the **[M]** key press and hold the PTT switch. The PTT switch will not initiate transmit during the programming of this channel.
6. Press the **[0]** key within 5 seconds of pressing the PTT switch to complete the operation. After you have pressed the **[0]** key in this step you may release the PTT key.

To operate on memory channel 0 you need only press the **[0]** key. The - and the + indicators will turn on to indicate that this memory channel now contains odd split frequency data.

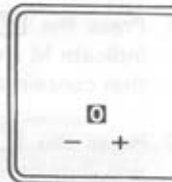

To cancel this odd split data simply store a new frequency into the memory channel.

● MEMORY CHANNEL LOCKOUT

The Memory Channel Lockout function allows you to temporarily skip unwanted memory channel(s).

1. Select the memory channel you wish to skip.
2. Press the **[F]** key. The F indicator will illuminate.
3. Press the **[0]** key within 5 seconds. The selected memory channel number will flash as an indication the Memory Channel has been locked out.

NOTE:

The channel number will not flash while the display is showing M and the listing of the memory channels that contain data. It will only flash when you recall the individual memory channel from the front panel directly.

4. To cancel the lockout press the desired memory channel number key and then press the **[F]** and **[0]** keys again.

● CLEARING A SPECIFIC MEMORY CHANNEL

1. Press the **[M]** key. The display will indicate M and any memory channels that contain data. (Ex. 1, 4, 5, 7, 8, 9)
2. Press the **[F]** key. The F indicator will illuminate.

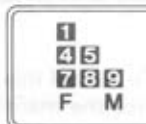
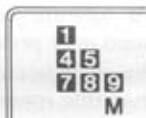

3. Press the key that corresponds to the channel you want to clear (Ex. 7) within 5 seconds of pressing the **[F]** key. The M, F, and channel number display will clear indicating the operation has been completed.
4. To confirm the data was erased press the **[M]** key.
(From our example the **[7]** will now be gone.)

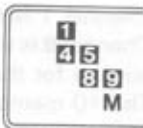

● CLEARING ALL MEMORIES (= Microprocessor Initialization)

To erase all data from the memories, turn the power switch on while pressing both the **[F]** and the **[ENTER]** keys together.

● MEMORY BACK-UP BATTERY

The transceiver includes a lithium back-up battery to retain memory in the microprocessor. When changing batteries, or if the Ni-Cd batteries should fully discharge, memory will always be retained.

If the display should begin to show erroneous information or numbers, the lithium battery needs replacement.

This should be performed by an authorized KENWOOD dealer since these components are easily damaged by static electricity.

■ PRIORITY ALERT CHANNEL CHECK

Memory channel 1 can be monitored at about 5 seconds intervals to check for activity.

Press the **[F]** key and then the 1/PRIO key, **[PRIO]** will appear on the display.

If the channel is busy, the **[PRIO]** indicator blinks, and if the BEEP function is ON, a beep will sound.

To stop the function, press the **[F]** and 1/PRIO keys again.

The function does not operate during scan or transmission.

■ BATTERY SAVER

Battery Saver operation provides to turn ON or OFF battery power automatically during reception and thus extend operation time.

2 ACTIVATION MODES

- 1. SAVE MODE:** The transceiver will activate the battery saver circuit 2 seconds after the squelch closes.
- 2. AUTO SAVE MODE:** The transceiver will activate the battery saver circuit 1 minute after the last key operation during the squelch closes.

To select the desired Battery Saver Mode, press the **[SAVE]** key. Each time press the key, radio will advance from SAVE to AUTO SAVE to OFF. The indicator will light;

SAVE MODE : **[SAVE]**
AUTO SAVE MODE : **[AUTO] / [SAVE]**
OFF : No indicator

Power Save Ratio Selection

To alter the actual length of time the receiver section shuts down, press the **[F]** key and then the **[SAVE]** key. The display will show the time the radio will be operating at reduced power levels (Ex. 1 : 1).

Use the **[▲]** or the **[▼]** key to select the desired save ratio from 1 : 1 to 1 : 9.

Press the **[ENTER]** key to complete the selection.

The radio will operate at reduced power consumption according to the accompanying diagram.

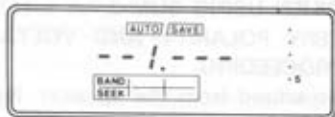

For example;

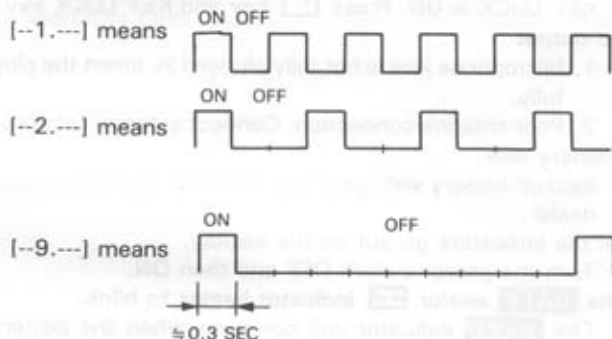

When a signal is received, the function is automatically cancelled. Since the receiver section shuts down, the squelch may not open by pressing the MONITOR switch.

MAINTENANCE

■ IN CASE OF DIFFICULTY

WHEN USING SUM-3/AA BATTERIES, ENSURE THE BATTERY POLARITY AND VOLTAGE IS CORRECT BEFORE PROCEEDING.

No sound from the speaker. No signal can be received.

1. Squelch is closed. Turn the SQL control counter-clockwise.
2. T.SQ is activated. Turn the SQL control clockwise past the detent position.
3. PTT switch of microphone is pressed setting the unit in the transmit mode. Turn PTT switch off.

No control works.

KEY LOCK is ON. Press  key and KEY LOCK key.

No output

1. Microphone jack is not fully plugged in. Insert the plug fully.
2. Poor antenna connection. Connect antenna securely.

Memory loss.

Backup battery voltage is low. Contact your authorized dealer.

All the indicators go out on the display.

Turn the power switch OFF and then ON.

The **BATT** and/or  indicator begins to blink.

The **BATT** indicator will come on when the battery needs recharging. If you continue to operate and the **BATT** and/or  indicator begins to blink the radio will no longer operate properly.

Replace/Recharge the battery when the **BATT** indicator comes on.

■ SERVICE

Should it ever become necessary to return the equipment to your dealer or service center for repair, pack in its original box and packing, and include a full description of the problems involved. Also include your telephone number. You need not return accessory items unless directly related to the service problem.

Service note: Dear OM, if you desire to correspond on a technical or operational problem, please make your note short, complete, and to the point. And PLEASE make it readable. Please list: Model and serial number. The question or problem you are having.

When claiming warranty service, a photocopy of the bill of sale, or other proof of purchase showing the date of sale must accompany the radio.

OPTION

PROGRAMMABLE TONE
DECODER UNIT
TSU-4



SPEAKER MICROPHONE
SMC-30



SOFT CASE
SC-27 (for PB-12)



SWIVEL MOUNT
BH-5

TELESCOPING ANTENNA
RA-3

SOFT CASE
SC-13
(for PB-1/4)



SOFT CASE
SC-12 (for PB-2/3)



MICRO HEADPHONES
HS-7

MICRO HEADPHONE
HS-8

MOBILE MOUNTING
BRACKET
MB-4
FILTERED CIGARETTE
LIGHTER CORD
PG-3E



DC CABLE
PG-2V



POWER SUPPLY

Ni-Cd RECHARGEABLE
BATTERY PACK

PB-1
12V 800mAh
Charge with
BC-7/8 only.



Ni-Cd RECHARGEABLE
BATTERY PACK

PB-3
7.2V 800mAh
Charge with
BC-7/8 only.



Ni-Cd RECHARGEABLE
BATTERY PACK

PB-1
8.4V 500mAh



Ni-Cd RECHARGEABLE
BATTERY PACK

PB-4
7.2V 1600mAh
Charge with
BC-7/8 only.



RAPID CHARGER

BC-7
(for PB-
1/2/3/4)



COMPACT CHARGER

BC-8
(for PB-1/2/3/4)



AA MANGANESE/
ALCALINE BATTERY
CASE

BT-5



BATTERY CHARGER

BC-2 (for PB-2 only)

Ni-Cd RECHARGEABLE
BATTERY PACK

PB-12
12V 500mAh



PROGRAMMABLE TONE DECODER UNIT (TSU-4)

Fig. 1

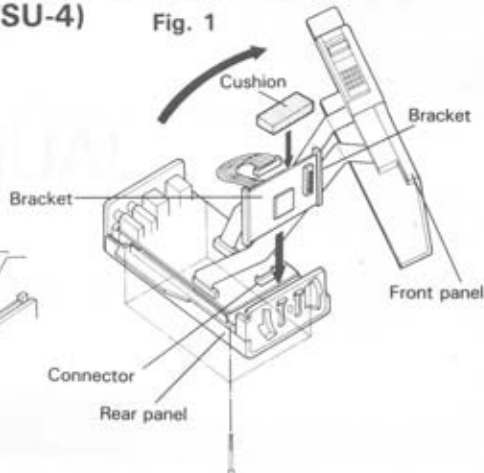
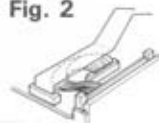

Fig. 2



1. Remove the four phillips head screws from the rear panel of the radio.
2. Gently remove the front panel. The panel should be rotated away from the PTT switch side.
3. Remove the foam cushion attached to the bottom of the set. Install the tone squelch unit between the bottom of the set and the main circuit board as shown in Fig. 1.
4. Attach the cable from the TSU-4 as shown in Fig. 2. The cable should be routed under the ribbon cable that goes to the front panel.
5. Remove the backing from the foam cushion that was provided with the TSU-4 and attach the cushion to the edge of the TSU-4.
6. Replace the covers and tighten screws to complete the installation.

NOTE:

Some optional accessories may not be available in your areas. Some cars may not be suitable to hook the MB-4 into the window. HMC-1 vox headset cannot be used.

PROGRAMMABLE TONE DECODER (UNIT TSU-4)



KENWOOD

1. Remove the front panel cover by pulling back of the tabs.
2. Carefully remove the front panel. The panel is held in place by the front panel cover. The panel cover is held in place by the front panel cover.
3. Remove the front panel cover by pulling back of the tabs.
4. Remove the front panel cover by pulling back of the tabs.
5. Remove the front panel cover by pulling back of the tabs.
6. Remove the front panel cover by pulling back of the tabs.
7. Remove the front panel cover by pulling back of the tabs.
8. Remove the front panel cover by pulling back of the tabs.

